

Data Sheet : SSL509

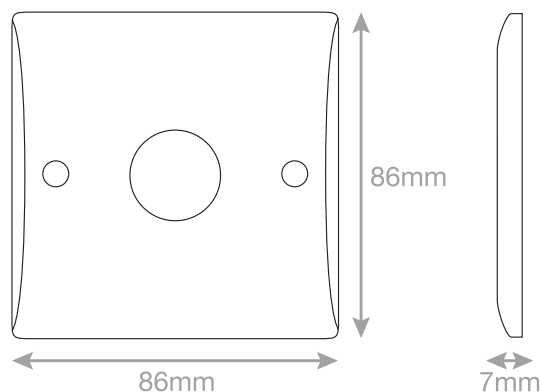

Code	SSL509
Description	Dimmer Push On / Off - No Derating - 1 Gang 2 Way 400 watt
Size	86mm x 86mm x 7mm depth
Range	Selectric Smooth
Colour	White
Material	Bakelite
Included	M3.5 fixing screws & white blanking caps
Weight	0.14kg
Inner Carton Quantity	10
Inner Carton Weight	1.4kg
Guarantee	3 years
Barcode	5025117986097
Commodity Code	85369085
Standards	BS EN 60669-1, BS EN 60669-2, BS EN 55015-2 & BS EN 61000-3
Notes	<ul style="list-style-type: none"> • Suitable for quality dimmable electronic and toroidal transformers without de-rating • Also suitable for tungsten lamps without de-rating • For use with resistive and inductive loads • Smooth dimming operation 0-100% light output • Max load: 400W – Min load: 60W • Empty dimmers plates also available to add your own dimmer module • Minimum back box size required: 25mm depth