

COMBI® 308 BK

Junction box 85x85x51mm, polypropylene, RAL 9005

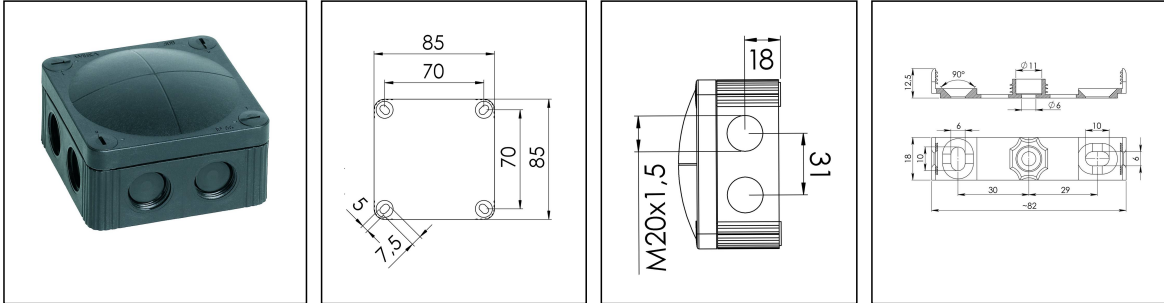

Products may differ in size, colour and appearance to those shown. If you require further information or customisation, please contact us directly.



Material	Polypropylene
Material sealing gasket	TPE
Temp. range min	-30 °C
Temp. range max	100 °C
Temperatures during install.	-5 °C - 60 °C
Protection class	IP66 / IP67
Glow wire test	750 °C
Voltage	400 V
Rated cross section	4 mm ²
Fixing	4 internal openings
Ø cable diameter min	3 mm
Ø cable diameter max	12 mm
External dimensions LxWxH	85 x 85 x 51mm
Type of cable gland	M 20 x 1,5
Using for cable gland	
Product Color	RAL 9005
WISKA-Order no.	10060581
Type	COMBI® 308 BK
Packing unit	5
ETIM-Classification	EC002600

Remarks:

Fixing: With mounting clip or 4 internal openings outside of the sealing area

Equipment: 8 elastic self-sealing puncture-membranes for cable entry

8 integrated M20 thread for mounting without lock nut

4 captive cover screws

Your Contact:

WISKA Hoppmann GmbH

Kisdorfer Weg 28 · 24568 Kaltenkirchen · Germany

☎ +49-4191-508-0 · 📠 +49-4191-508-209

contact@wiska.de · www.wiska.com

including mounting clip

Recommended accessories

DIN Rail Kit - COMBI® 108 / 308	10060362
MP-S Mounting plate small	10105774
MP-L Mounting plate large COMBI® / WHK	10105775
External mounting - COMBI®	10108836
ZER 4-12	10109800

25.02.2020

Your Contact:

WISKA Hoppmann GmbH

Kisdorfer Weg 28 · 24568 Kaltenkirchen · Germany

☎ +49-4191-508-0 · 📠 +49-4191-508-209

contact@wiska.de · www.wiska.com



Your Contact:

WISKA Hoppmann GmbH

Kisdorfer Weg 28 · 24568 Kaltenkirchen · Germany

☎ +49-4191-508-0 · 📠 +49-4191-508-209

contact@wiska.de · www.wiska.com

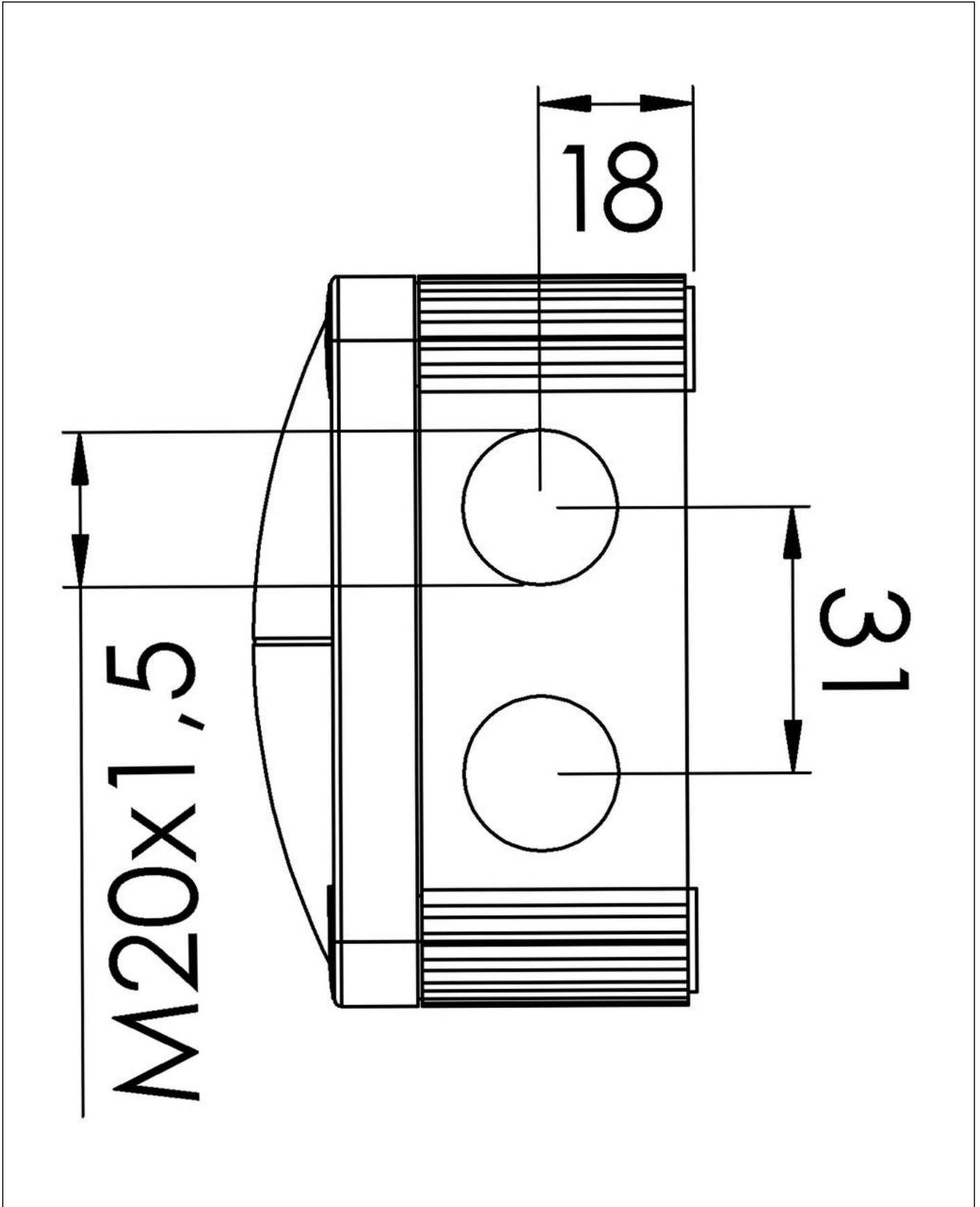

Your Contact:

WISKA Hoppmann GmbH

Kisdorfer Weg 28 · 24568 Kaltenkirchen · Germany

☎ +49-4191-508-0 · 📠 +49-4191-508-209

contact@wiska.de · www.wiska.com